

Basics of measuring the dielectric properties of materials

Application Note 1217-1

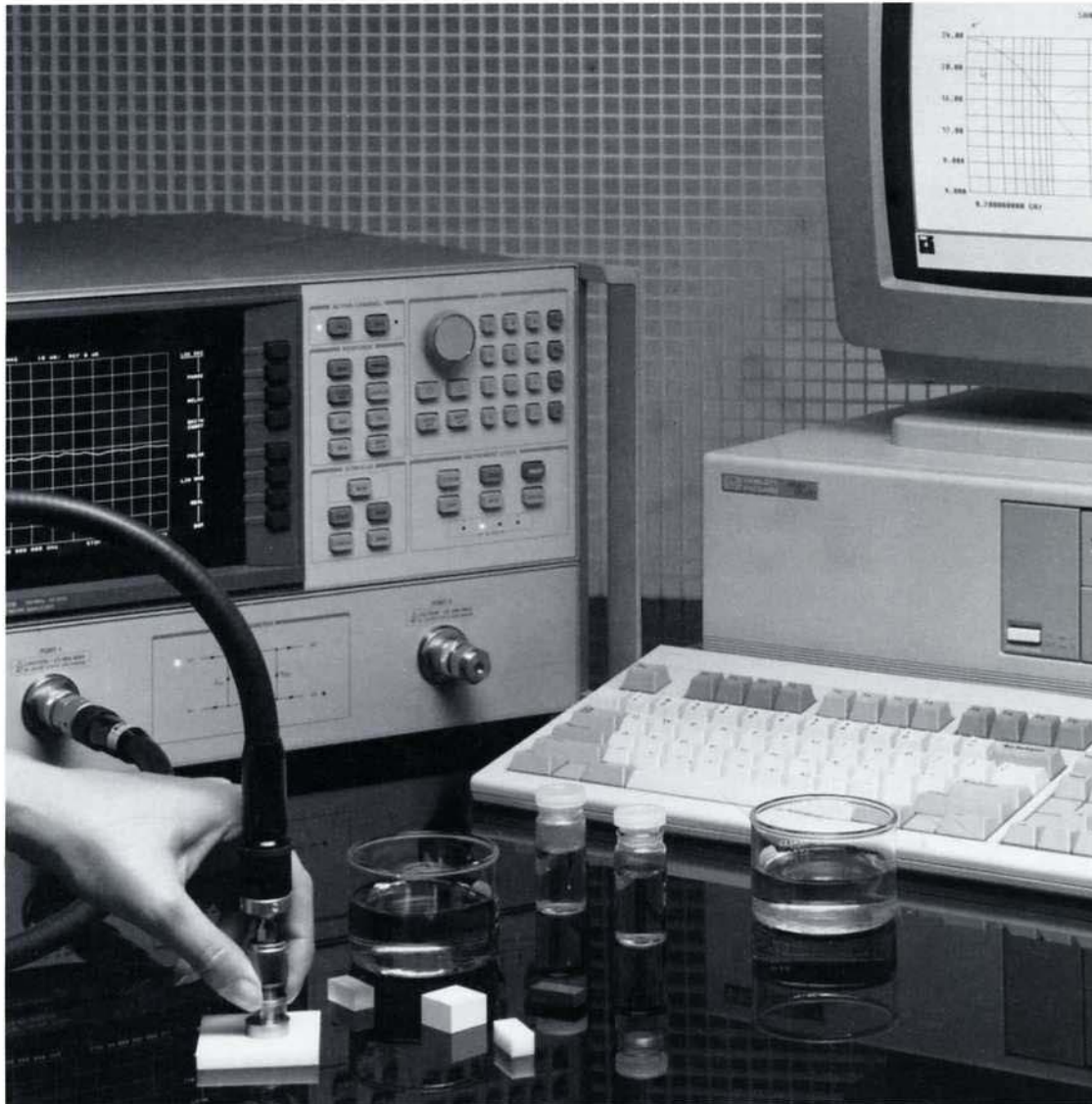

Contents

	Page
Dielectric theory	3
Dielectric mechanisms	6
Measurement systems	9
Measurement techniques	11
Glossary of terminology	15
Literature reference	16

Introduction

Every material has a unique set of electrical characteristics that are dependent on its dielectric properties. Accurate measurements of these properties can provide scientists and engineers with valuable information to properly incorporate the material into its intended application for more solid designs or to monitor a manufacturing process for improved quality control.

A dielectric materials measurement can provide critical design parameter information for many electronics applications. For example, the loss of a cable insulator, the impedance of a substrate, or the frequency of a dielectric resonator can be related to its dielectric properties. The information is also useful for improving ferrite, absorber, and packaging designs. More recent applications in the area of industrial microwave processing of food, rubber, plastic and ceramics have also been found to benefit from a knowledge of dielectric properties.

Hewlett-Packard Company offers a variety of instruments, fixtures and software to measure the dielectric properties of materials. HP's measurement instruments, such as DC high resistance meters, LCR meters, impedance analyzers and network analyzers range in frequency from DC to 110 GHz. Fixtures to hold the material under test (MUT) are available that are based on the resistivity cell, parallel plate, coaxial probe, and coaxial/waveguide transmission line techniques.

Dielectric theory

The dielectric properties that will be discussed here are resistivity, permittivity and permeability. It is important to note that these properties are not constant. They can change with frequency, temperature, orientation, mixture, pressure and molecular structure of the material.

Resistivity

Resistivity is a DC-resistance measurement of a material. High resistivity is an important characteristic for insulating materials, while low resistivity is important for conducting materials.

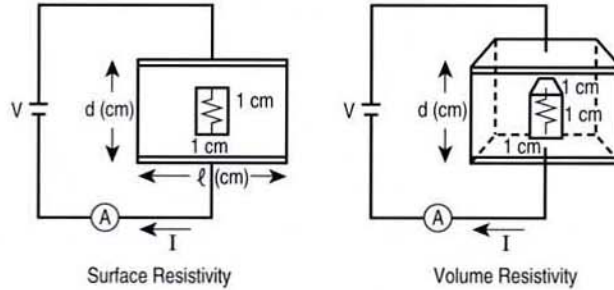

Figure 1.
Resistivity

$$\rho_S = R \cdot (\ell / d)$$

$$\rho_V = R \cdot (S/d)$$

where: ρ_S = resistance per unit area (Ω)
 ρ_V = resistance per unit volume ($\Omega \cdot \text{cm}$)
 R = resistance (Ω) = V/I
 S = surface area of material under test (cm^2)
 d = thickness of material under test (cm)
 ℓ = length of material under test (cm)

Dielectric constant

A material is classified as “dielectric” if it has the ability to store energy when an external electric field is applied. If a DC voltage source is placed across a parallel plate capacitor, more charge is stored when a dielectric material is between the plates than if no material (a vacuum) is between the plates. The dielectric material increases the storage capacity of the capacitor by neutralizing charges at the electrodes which ordinarily would contribute to the external field. The capacitance with the dielectric material is related to dielectric constant.

$$C = C_0 \kappa'$$

$$\kappa' = C/C_0$$

where: κ' = dielectric constant of the material
 C = capacitance with material = q_d/V
 C_0 = capacitance without material (vacuum) = A/t

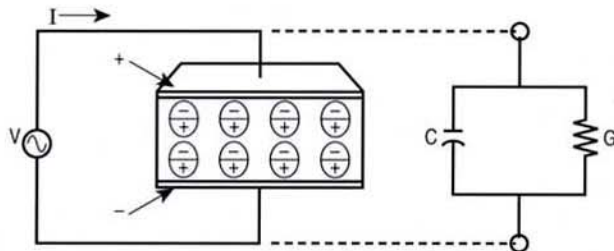

Figure 2.
Parallel plate capacitor

If an AC sinusoidal voltage source is placed across the same capacitor, the resulting current will be made up of a charging current and a loss current that is related to the dielectric constant. The losses in the material can be represented as a conductance (G) in parallel with a capacitor (C).

$$I = I_{\text{charge}} + I_{\text{loss}} = V(j\omega C + G) = V(j\omega C_0 \kappa' + G)$$

$$\text{Let } G = \omega C_0 \kappa''$$

$$I = V(j\omega C_0 \kappa' + \omega C_0 \kappa'') = V(j\omega C_0)(\kappa' - j\kappa'') = V(j\omega C_0) \kappa^*$$

$$\kappa^* = \kappa' - j\kappa''$$

The complex dielectric constant (κ^*) consists of a real part (κ') which represents the storage and an imaginary part (κ'') which represents the loss.

Permittivity

Permittivity (ϵ) describes the interaction of a material with an electric field. Dielectric constant (κ) is equivalent to relative permittivity ($\epsilon_r = \epsilon/\epsilon_0$), or the permittivity relative to free space.

$$\epsilon_r^* = \kappa^* = \epsilon^*/\epsilon_0 = (\epsilon'/\epsilon_0) - j(\epsilon''/\epsilon_0)$$

where: ϵ_r^* = complex relative permittivity
 ϵ_0 = permittivity in free space = 8.854×10^{-12} Farad/m

The real part of permittivity (ϵ_r') is a measure of how much energy from an external electric field is stored in a material. ϵ_r' is > 1 for most solids and liquids. The imaginary part of permittivity (ϵ_r'') is called the loss factor. It is a measure of how dissipative or lossy a material is to an external electric field. ϵ_r'' is always > 0 and is usually much smaller than ϵ_r' . The loss factor includes the effects of both dielectric loss and conductivity.

Loss tangent

When complex permittivity is drawn as a simple vector diagram, the real and imaginary components are 90° out of phase. The vector sum forms an angle δ with the real axis (ϵ_r'). The relative "lossiness" of a material is the ratio of the energy lost to the energy stored.

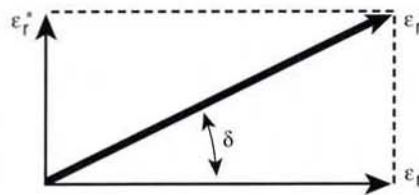

Figure 3. Loss tangent vector diagram

$$\tan \delta = I_{\text{loss}}/I_{\text{charge}} = \kappa''/\kappa' = \epsilon_r''/\epsilon_r' = \epsilon''/\epsilon'$$

$$\tan \delta \propto (\text{Energy lost per cycle}) / (\text{Energy stored per cycle})$$

$$\tan \delta = D = 1/Q$$

where: $\tan \delta$ = loss tangent, tan delta, tangent loss, etc.

Q = quality factor

D = dissipation factor

Permeability

Permeability (μ) describes the interaction of a material with a magnetic field. A similar analysis can be performed for permeability using an inductor with resistance to represent core losses in a magnetic material. If a DC current source is placed across an inductor, the inductance with the core material can be related to permeability.

$$L = L_0 \mu'$$

$$\mu' = L/L_0$$

where: μ' = permeability of the core material

L = inductance with material

L_0 = inductance without material (vacuum)

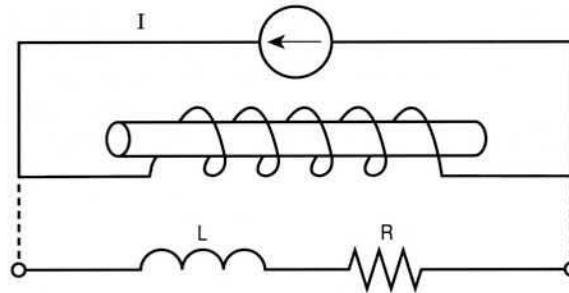

Figure 4. Inductor

If an AC sinusoidal current source is placed across the same inductor, the resulting voltage will be made up of an induced voltage and a loss voltage that is related to permeability. The core losses can be represented by a resistance (R) in series with an inductor (L).

$$V = V_{\text{induced}} + V_{\text{loss}} = I(j\omega L + R) = I(j\omega L_0 \mu' + R)$$

$$\text{Let } R = \omega L_0 \mu''$$

$$V = I(j\omega L_0 \mu' + \omega L_0 \mu'') = I(j\omega L_0)(\mu' - j\mu'') = I(j\omega L_0) \mu^*$$

$$\mu^* = \mu' - j\mu''$$

The complex permeability (μ^*) consists of a real part (μ') that represents the energy storage term and an imaginary part (μ'') that represents the energy loss term. Relative permeability (μ_r) is the permeability relative to free space.

$$\mu_r^* = \mu^* / \mu_0 = (\mu' / \mu_0) - j(\mu'' / \mu_0)$$

where: μ_r^* = complex relative permeability
 μ_0 = permeability in free space = $4\pi \times 10^{-7}$ Henry/m

Some materials such as iron (ferrites), cobalt, nickel and their alloys have appreciable magnetic properties; however, many materials are nonmagnetic, making the permeability very close to the permeability of free space ($\mu_r = 1$). All materials, on the other hand, have dielectric properties, so the focus of this discussion will be on permittivity measurements only.

Electromagnetic wave propagation

In the time-varying case (i.e., a sinusoid), electric fields and magnetic fields appear together. This electromagnetic wave can propagate through free space (at the speed of light, $c = 3 \times 10^8$ m/s) or through materials. Electromagnetic waves of various wavelength exist. The wavelength of a signal is inversely proportional to its frequency ($\lambda = c/f$) such that as the frequency increases, the wavelength decreases. For example, in free space a 10 MHz signal has a wavelength of 30 m, while at 10 GHz it is just 3 cm.

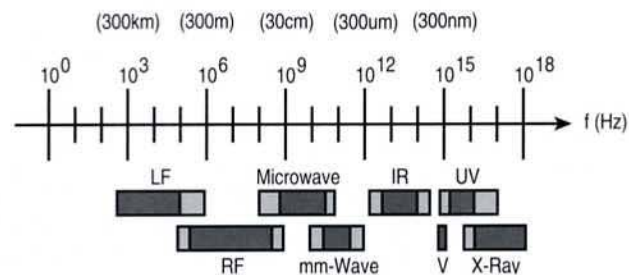

Figure 5. Electromagnetic spectrum

Many aspects of wave propagation are dependent on the permittivity and permeability of a material. As a wave propagates from free space into material, an impedance mismatch occurs at the boundary causing part of the energy to be reflected from the material and the rest of the energy to be transmitted through the material. Once inside the material, the wave's velocity and wavelength are decreased. If the material is lossy, there will be attenuation or insertion loss through the material.

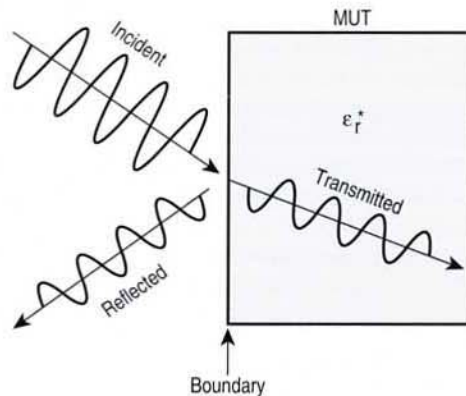

Figure 6. Reflected and transmitted signals

Dielectric mechanisms

A material may have several dielectric mechanisms or polarization effects that contribute to its overall permittivity. A dielectric material has an arrangement of electric charge carriers that can be displaced by an electric field. The charges become polarized to compensate for the electric field such that the positive and negative charges move in opposite directions.

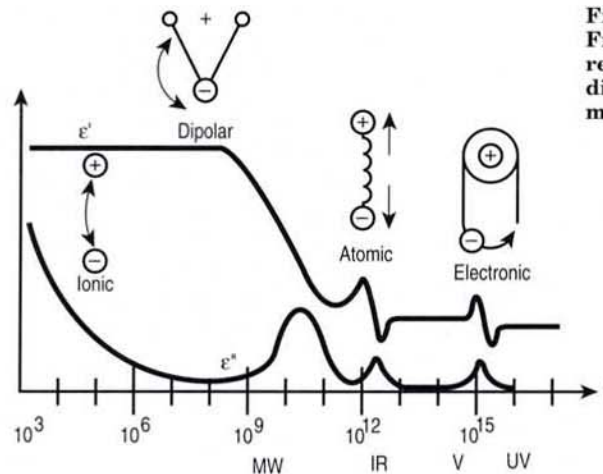

Figure 7. Frequency response of dielectric mechanisms

Each dielectric mechanism effect has a characteristic resonant frequency or relaxation frequency. As the frequency increases, the slower mechanisms drop out, leaving the faster ones to contribute to the storage (ϵ_r'). The loss factor (ϵ_r'') will correspondingly peak at each critical frequency. A resonant effect is usually associated with electronic or atomic polarization. A relaxation effect is usually associated with orientation polarization.

Electronic and atomic polarization

Electronic polarization occurs in neutral atoms when an electric field displaces the nucleus with respect to the electrons that surround it. Atomic polarization occurs when adjacent positive and negative ions "stretch" under an applied electric field. For many dry solids, these are the dominant polarization mechanisms at microwave frequencies, although the actual resonance occurs at a much higher frequency.

Resonant frequency

In the infrared and visible light regions the inertia of the orbiting electrons must be taken into account. Atoms can be modeled as oscillators with a damping effect similar to a mechanical spring and mass system. The amplitude of the oscillations will be small for any frequency other than the resonant frequency. Far below resonance, the electronic and atomic mechanisms contribute only a small constant amount to ϵ_r' and are almost lossless. The resonant frequency is identified by a resonant response in ϵ_r' and a peak of maximum absorption in ϵ_r'' . Above the resonance, the contribution from these mechanisms disappears.

Orientation polarization

A molecule is formed when atoms combine to share one or more of its electrons. This rearrangement of electrons may cause an imbalance in charge distribution creating a permanent dipole moment. These moments are oriented in a random manner in the absence of an electric field so that no polarization exists. Under the effect of an electric field, the dipoles rotate to align with the electric field causing orientation polarization to occur. The dipole rotation causes a variation in both ϵ_r' and ϵ_r'' at the relaxation frequency which usually occurs in the microwave region. Water is an example of a substance that exhibits a strong orientation polarization.

Relaxation time

Relaxation time (τ) is a measure of the mobility of the molecules that exist in a material. It is the time required for a displaced system aligned in an electric field to return to $1/e$ of its random equilibrium value. Liquid and solid materials have molecules that are in a condensed state with limited freedom to move when an electric field is applied. Constant collisions cause internal friction so that the molecules turn slowly and exponentially approach the final state of orientation polarization with relaxation time constant τ . When the field is switched off, the sequence is reversed and random distribution is restored with the same time constant.

The relaxation frequency is inversely related to relaxation time ($f_{\text{relax}} = 1/2\pi\tau$). At frequencies below relaxation the alternating electric field is slow enough that the dipoles are able to keep pace with the field variations. Because the polarization is able to develop fully, the loss (ϵ_r'') is directly proportional to the frequency. As the frequency increases, ϵ_r'' continues to increase but the storage (ϵ_r') begins to decrease due to the phase lag between the dipole alignment and the electric field. Above the relaxation frequency both ϵ_r'' and ϵ_r' drop off as the electric field is too fast to influence the dipole rotation and the orientation polarization disappears.

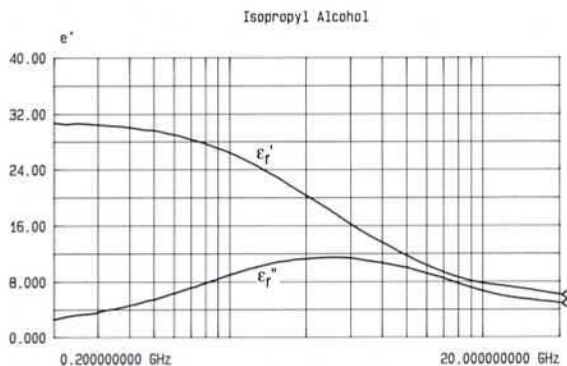

Figure 8.
Measurement of
isopropyl alcohol
showing orientation
polarization

Materials that exhibit a single relaxation time constant can be modeled by the Debye relation which appears as a characteristic response in permittivity as a function of frequency (Figure 8). ϵ_r' is constant above and below the relaxation with the transition occurring near the relaxation frequency. Additionally, ϵ_r'' is small above and below relaxation and peaks in the transition region at the relaxation frequency.

Cole-Cole diagram

The complex permittivity may also be shown on a Cole-Cole diagram by plotting the imaginary part (ϵ_r'') on the vertical axis and the real part (ϵ_r') on the horizontal axis with frequency as the independent parameter.

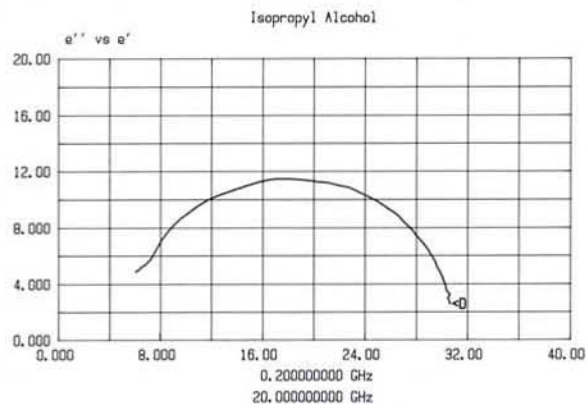

Figure 9.
Measurement of isopropyl alcohol showing a Cole-Cole diagram

A material that has a single relaxation frequency as exhibited by the Debye relation will appear as a semicircle with its center lying on the horizontal $\epsilon_r''=0$ axis and the peak of the loss factor occurring at $1/\tau$. A material with multiple relaxation frequencies will be a semicircle (symmetric distribution) or an arc (nonsymmetric distribution) with its center lying below the horizontal $\epsilon_r''=0$ axis.

Ionic conductivity

The measured loss of material can actually be expressed as a function of both dielectric loss (ϵ_{rd}'') and conductivity (σ).

$$\epsilon_r'' = \epsilon_{rd}'' + \frac{\sigma}{\omega\epsilon_0}$$

At low frequencies, the overall conductivity can be made up of many different conduction mechanisms, but ionic conductivity is the most prevalent in moist materials. ϵ_r'' is dominated by the influence of electrolytic conduction caused by free ions which exist in the presence of a solvent (usually water). Ionic conductivity only introduces losses into a material. At low frequencies the effect of ionic conductivity is inversely proportional to frequency and appears as a $1/f$ slope of the ϵ_r'' curve (Figure 10).

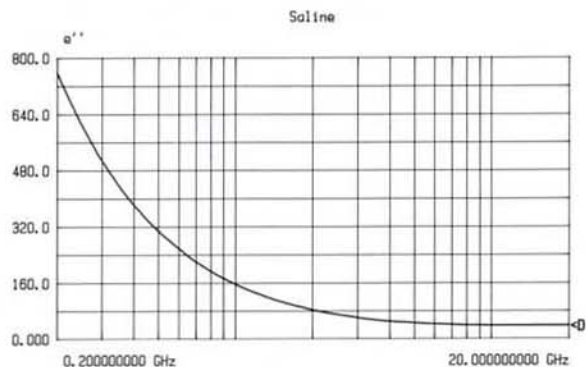

Figure 10.
Measurement of saline showing ionic conductivity

Interfacial or space charge polarization

Electronic, atomic and orientation polarization occur when charges are locally bound in atoms, molecules or structures of solids or liquids. Charge carriers also exist that can migrate over a distance through the material when a low frequency electric field is applied. Interfacial or space charge polarization occurs when the motion of these migrating charges is impeded. The charges can become trapped within the interfaces of a material. Motion may also be impeded when charges cannot be freely discharged or replaced at the electrodes. The field distortion caused by the accumulation of these charges increases the overall capacitance of a material which appears as an increase in ϵ_r' .

Mixtures of materials with electrically conducting regions that are not in contact with each other (separated by nonconducting regions) exhibit the Maxwell-Wagner effect at low frequencies (Figure 11). If the charge layers are thin and much smaller than the particle dimensions, the charge responds independently of the charge on nearby particles. At low frequencies the charges have time to accumulate at the borders of the conducting regions causing ϵ_r' to increase. At higher frequencies the charges do not have time to accumulate and polarization does not occur since the charge displacement is small compared to the dimensions of the conducting region. As the frequency increases, ϵ_r' decreases and the losses exhibit the same $1/f$ slope as normal ionic conductivity.

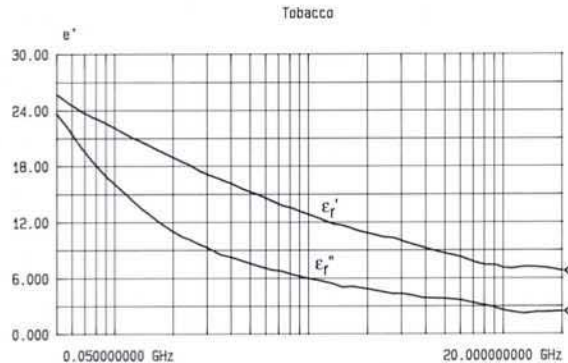

Figure 11.
Measurement of tobacco showing the Maxwell-Wagner effect

Many other dielectric mechanisms can occur in this low frequency region causing a significant variation in permittivity. For example, colloidal suspension occurs if the charge layer is on the same order of thickness or larger than the particle dimensions. The Maxwell-Wagner effect is no longer applicable since the response is now affected by the charge distribution of adjacent particles.

Measurement systems

High resistance meters

A high resistance meter, such as the HP 4339A, measures the surface and volume resistivity of insulation-like material by applying a high DC test voltage such that the potential is distributed over one side (surface) or both sides (volume) of the sample. Resistivity values are derived by measuring the DC current and by knowing the size of the electrodes and the dimensions of the sample. Suitable test cells for solids, sheet samples and liquids can be used.

$$R_x = V/A$$

$$R_x \gg (R_s + R_i)$$

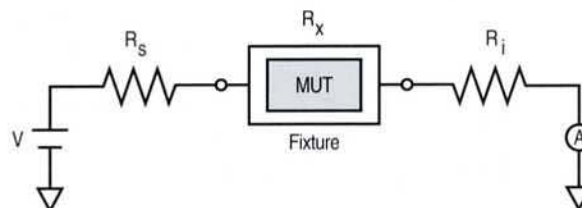

Figure 12. DC high resistance meter

LCR meters and impedance analyzers

LCR meters and impedance analyzers such as the HP 4284A, 4285A and 4194A use the auto-balancing bridge technique to measure the impedance of materials. The material is stimulated with an AC source and the actual voltage across the material is monitored between the high (H) and low (L) terminals. The low terminal is driven to 0 V by a virtual ground of the op amp. The output voltage is proportional to the current through the material.

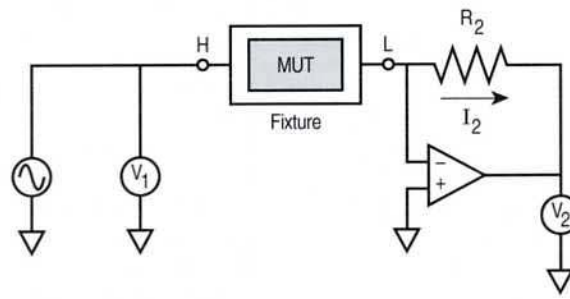

Figure 13. Auto-balancing bridge

$$Z = \frac{V_1}{I_2} = \frac{V_1 R_2}{V_2}$$

Material test parameters are derived by knowing the dimensions of the material and by measuring its capacitance and dissipation factor. The auto-balancing bridge technique provides highly accurate capacitance and low dissipation factor measurements between 5 Hz to 40 MHz.

Network analyzers

A measurement of the reflection from and/or transmission through a material along with a knowledge of its physical dimensions provides the information to characterize the permittivity and permeability of the material. Vector network analyzers such as the HP 8753, 8720 and 8510 make swept high frequency stimulus-response measurements from 300 kHz to 110 GHz.

A vector network analyzer consists of a signal source, a receiver and a display. The source launches a signal at a single frequency to the material under test. The receiver is tuned to that frequency to detect the reflected and transmitted signals from the material. The measured response produces the magnitude and phase data at that frequency. The source is then stepped to the next frequency and the measurement is repeated to display the reflection and transmission measurement response as a function of frequency.

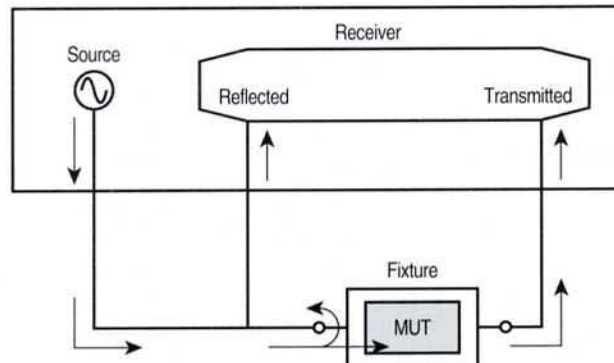

Figure 14. Network analyzer

Simple components and connecting wires that perform well at low frequencies behave differently at high frequencies. At microwave frequencies wavelengths becomes small compared to the physical dimensions of the devices such that two closely spaced points can have a significant phase difference. Low frequency lumped-circuit element techniques must be replaced by transmission line theory to analyze the behavior of devices at higher frequencies. Additional high frequency effects such as radiation loss, dielectric loss and capacitive coupling make microwave circuits more complex and expensive.

It is time consuming and costly to try to design a perfect microwave network analyzer. Instead, a measurement calibration is used to eliminate the systematic (stable and repeatable) measurement errors caused by the imperfections of the system. Random errors due to noise, drift or the environment (temperature, humidity, pressure) cannot be removed with a measurement calibration. This makes a microwave measurement susceptible to errors from small changes in the measurement system. These errors can be minimized by adopting good measurement practices such as visually inspecting all connectors for dirt or damage, and by minimizing any physical movement of the test port cables after a calibration.

- Fixtures** Before the dielectric properties of a material can be measured with one of these instruments, a measurement fixture is required to apply the electromagnetic fields in a predictable way and to allow connection to the measurement instrument. The type of fixture required will depend on the chosen measurement technique and the physical properties of the material (solid, liquid, powder, gas).
- Software** The measured data from the instrument is not always presented in the most convenient terminology or format. In this case, software is required to convert the measured data to permittivity or permeability. Software may also be required to model any interaction between the fixture and MUT to allow the extraction of the bulk material properties.

Measurement techniques

- Resistivity cell** The resistivity cell method is used to measure volume and surface resistivity of solid plate materials. The material is placed between two plates, a main and guard electrode. The measurement is performed by applying a high DC test voltage on one side (surface resistivity) or on both sides (volume resistivity) of the sample.

A typical measurement system using a resistivity cell method consists of a high resistance meter and an HP 16008B Resistivity Cell.

- Parallel plate** The parallel plate method involves sandwiching a thin sheet of material between two electrodes to form a capacitor. An LCR meter or impedance analyzer is used to measure the loaded fixture. ϵ_r' is computed from the measurement of capacitance (C) and ϵ_r'' is computed from the measurement of dissipation (D). A knowledge of the physical dimensions of the material is required.

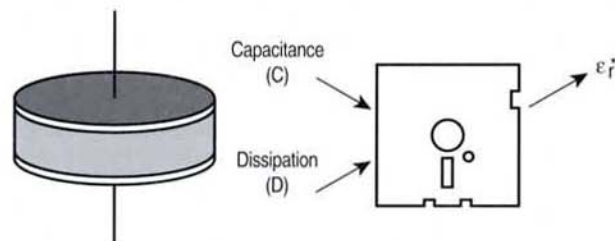

Figure 15.
Parallel plate method

A typical measurement system using a parallel plate method consists of an LCR meter or impedance analyzer and a fixture such as the HP 16451B dielectric test fixture which operates up to 30 MHz.

Coaxial probe

The open-ended coaxial probe is a cut off section of transmission line. The material is measured by touching the probe to a flat face of a solid or immersing it into a liquid. The fields at the probe end "fringe" into the material and change as they come into contact with the MUT. The reflected signal (S_{11}) can be measured and related to ϵ_r^* .

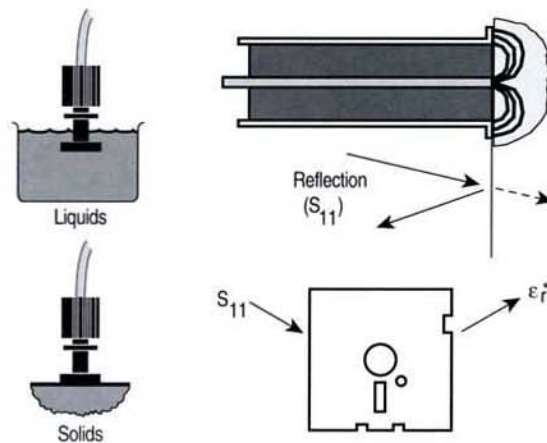

Figure 16. Coaxial probe method

A typical measurement system using a coaxial probe method consists of a network analyzer, a coaxial probe and software both of which are included in the HP 85070 dielectric probe kit, and an external computer.

Transmission line

Transmission line methods involve placing the material inside a portion of an enclosed transmission line. The line is usually a section of rectangular waveguide or coaxial airline. ϵ_r^* and μ_r^* are computed from the measurement of the reflected signal (S_{11}) and transmitted signal (S_{21}).

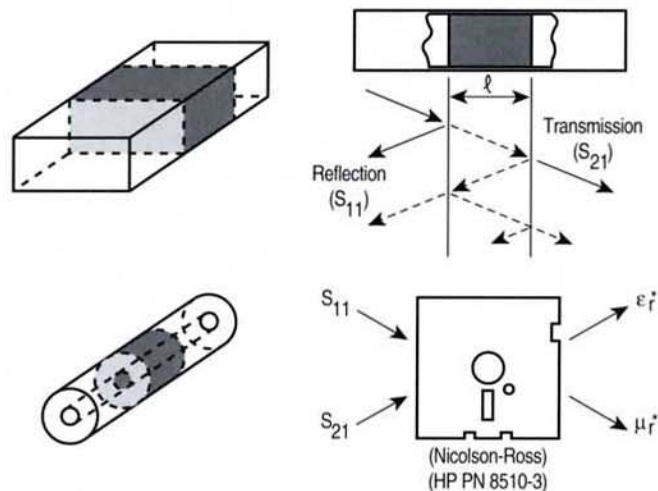

Figure 17. Transmission line method

Coaxial transmission lines cover a broad frequency range, but a toroid-shaped sample is more difficult to manufacture. Waveguide is a banded media, but the required brick-shaped sample is easier to manufacture.

A typical measurement system using a transmission line technique consists of a vector network analyzer, a coaxial airline or waveguide section, software such as the HP 85071 materials measurement software to perform the conversion to ϵ_r^* and μ_r^* , and an external computer.

Resonant Cavity

Cavities are high-Q structures that resonate at certain frequencies. A sample of the material affects the center frequency (f_c) and quality factor (Q) of the cavity. From these parameters, the complex permittivity of the material can be calculated.

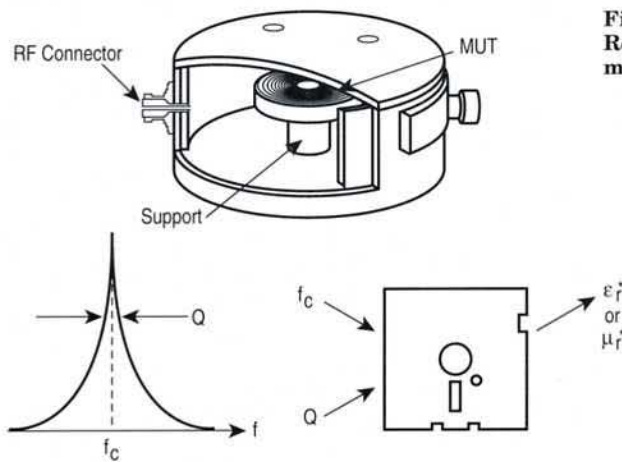

Figure 18.
Resonant cavity
method

A typical measurement system using a resonant cavity method consists of a network analyzer (with high frequency resolution), a cavity, software and an external computer.

Free space

Free-space methods use antennas to focus microwave energy at or through a slab of material without the need of a test fixture. This method is noncontacting and can be applied to materials to be tested under high temperatures and hostile environments. Both the transmission line and resonant cavity methods can be implemented as free-space measurements.

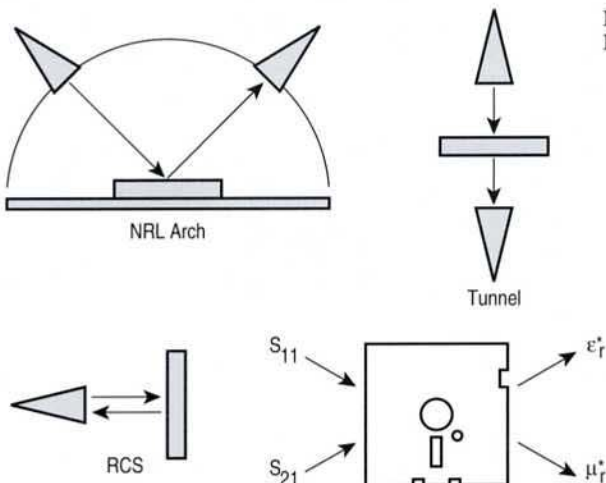

Figure 19.
Free-space method

A typical measurement system using a free-space method consists of a vector network analyzer, a “fixture” (antennas, tunnels, arches, etc.), software and an external computer.

Comparison of methods

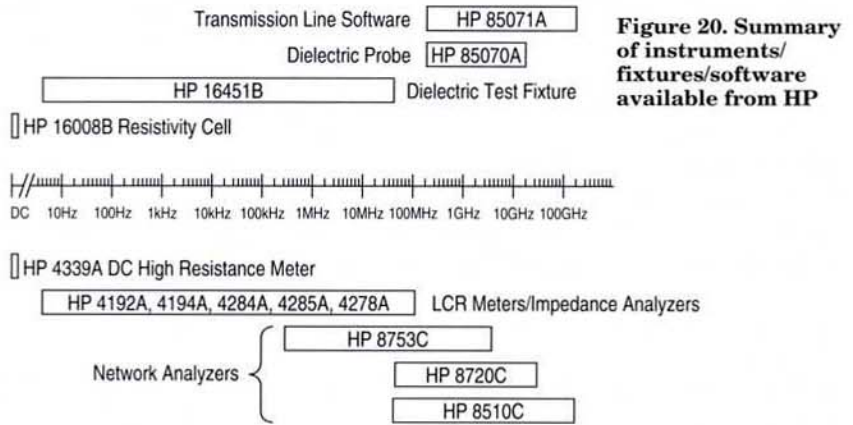

Figure 20. Summary of instruments/fixtures/software available from HP

Method	Parameter	Frequency (typical)	Comments
Resistivity cell	ρ_V or ρ_S	DC	Requires flat, disk-shaped sample. Ideal for sheets, film/grease. Inexpensive, simple analysis.
Parallel plate	ϵ_r^* only	< 30 MHz	Requires flat, disk-shaped sample. Ideal for thin sheets, films. Special fixture for liquids. Inexpensive, simple analysis.
Coaxial probe	ϵ_r^* only	200 MHz to 20 GHz	Ideal for liquids, semi-solids. Solids must have flat surface. Convenient, easy to use. Usually nondestructive. Limited low-loss resolution.
Transmission line	ϵ_r^* and μ_r^*	500 MHz to 110 GHz	Requires brick or toroid-shaped sample. Simple fixtures. Liquids and gases must be contained. Usually destructive. Limited low-loss resolution.
Cavity	ϵ_r^* or μ_r^*	500 MHz to 110 GHz	Requires precisely known sample shape. Usually destructive. Very accurate. Sensitive to low-loss tangents. Analysis may be complex.
Free space	ϵ_r^* and μ_r^*	2 GHz to 110 GHz	Requires flat, parallel faced sample. Large sample required (>3x beamwidth across). Noncontacting, no fixture required. Usually nondestructive.

Glossary of terminology

atomic polarization: A dielectric mechanism where bonds between atoms in a molecule are "stretched" in response to an electric field.

Cole-Cole plot: A data format with ϵ_r'' on the vertical axis and ϵ_r' on the horizontal axis. Frequency is the independent parameter.

conductivity: Usually ionic dielectric loss. In a dielectric measurement it does not mean true conduction (movement of electrons).

δ : Angle formed between the j -axis and the vector representing the sum of the storage and loss vectors.

D: See dissipation factor.

Debye functions: A simplified model to explain dielectric properties of polar molecules versus frequency, assuming that a single relaxation phenomenon is acting.

dielectric constant: ϵ_r or κ . The ratio of electric field storage capacity in a material to that of free space; usually means real (lossless) case only.

dielectric loss: The energy lost (or absorbed) in a material when applying an AC electric field.

dipole: A structure where the net charge distribution can be represented by two equal and opposite charges separated by distance.

dissipation factor: D . Ratio of energy lost to energy stored (per cycle) in a system. Also referred to as $\tan \delta$, loss tangent, inverse Q .

ϵ : See permittivity.

ϵ_0 : Permittivity in free space. Approximately equal to 8.854×10^{-12} Farad/m.

ϵ_r : See relative permittivity.

electronic polarization: A dielectric mechanism where the shell of orbiting electrons is distorted under an applied electric field.

heterogeneous: A nonuniform mixture of different substances.

homogeneous: Properties do not vary with position or location of the applied field.

ionic: A dielectric mechanism where mobile ionic charges migrate in a material.

isotropic: Properties do not vary with orientation or direction of the applied field. Non-isotropic materials are usually fibrous or crystalline.

κ : See dielectric constant.

linear: Properties do not vary with the magnitude or strength of the applied field.

loss factor: ϵ_r'' . A measure of how dissipative a material is to an electric field.

loss tangent: $\tan \delta$. Ratio of ϵ_r'' to ϵ_r' . Indicates the "lossiness" of a material.

Maxwell-Wagner effect: Causes ϵ_r'' to slope downward in addition to the $1/f$ downward slope of ϵ_r'' at low frequencies for materials that contain conducting regions embedded in nonconducting regions.

orientation polarization: A dielectric mechanism where permanent dipoles rotate to align with an applied electric field.

penetration depth: Distance through a lossy dielectric over which the field strength falls by $1/e$, due to energy absorption.

permanent dipoles: Molecular structures that inherently have a non-symmetrical charge distribution.

permeability: μ . A measure of the interaction of a material with a magnetic field.

permittivity: ϵ . A measure of the interaction of a material with an electric fields.

polar: Having permanent dipole moments.

polarization: The displacement of charges to compensate for the effects of an applied electric field.

Q: See quality factor.

quality factor: Q . The ratio of energy stored to energy lost (per cycle) in a system. Also known as inverse $\tan \delta$ and $1/D$.

ρ : See resistivity.

relative permittivity: ϵ_r . Permittivity relative to free space.

relative permeability: μ_r . Permeability relative to free space.

relaxation frequency: f_{relax} . Frequency corresponding the inverse of the relaxation time ($1/2\pi\tau$).

relaxation time constant: τ . The time it takes for $1/e$ of the constituent molecules to become aligned in response to an electric field.

resistivity: ρ . The degree to which a material resists a current flow.

resonant frequency: Frequency at which atomic and electronic polarization occurs.

S_{11} : Forward reflection coefficient. Scattering parameter (S-parameter) representing the ratio of the reflected signal to the incident signal.

S_{21} : Forward transmission coefficient. Scattering parameter (S-parameter) representing the ratio of the transmitted signal to the incident signal.

space charge polarization: A dielectric mechanism where positive and negative ions move in opposite directions in response to an applied electric field.

τ : See relaxation time constant.

$\tan \delta$: See loss tangent.

μ : See permeability.

μ_0 : Permeability of free space. $4\pi \times 10^{-7}$ Henry/m.

μ_r : See relative permeability.

Literature reference

1. Altschuler, H.M., "Dielectric Constant," Chapter IX of **Handbook of Microwave Measurements**, M. Sucher and J. Fox (ed), Wiley, 1963.
2. Asfar, M. et al, "Measurement of the Properties of Materials," *IEEE Proceedings* 72 (1), January 1986.
3. ASTM, "Test methods for A-C loss characteristics and permittivity (dielectric constant) of solid electrical insulating materials," *ASTM Standard D 150*, American Society for Testing and Materials.
4. ASTM, "Test methods for D-C resistance or conductance of insulating materials," *ASTM Standard D 257*, American Society for Testing and Materials.
5. ASTM, "Test methods for complex permittivity (Dielectric Constant) of solid electrical insulating materials at microwave frequencies and temperatures to 1650°C," *ASTM Standard D 2520*, American Society for Testing and Materials.
6. Geyer, R.G., "Dielectric characterization and reference materials," *NIST Technical Note 1338*, National Institute of Standards and Technology, April 1990.
7. Nyfors, Ebbe and Pertti Vainikainen, **Industrial Microwave Sensors**, Massachusetts: Artech House Inc., 1989.
8. von Hippel, Arthur (ed), **Dielectric Materials and Applications**, Cambridge, Massachusetts: MIT Press, 3rd printing, January 1961.

Hewlett-Packard literature

1. Application Note 339, "Parametric analysis for electronic components and circuit evaluation using the HP 4194A," *HP literature number 5950-2856*.
2. Application Note 339-5, "Multi-frequency C-V measurements and doping profile analysis of semiconductors using the HP 4194A," *HP literature number 5950-2919*.
3. Application Note 339-13, "Measuring the dielectric constant of solid materials - HP 4194A impedance/gain-phase analyzer," *HP literature number 5950-2935*, December 1987.
4. Application Note 380-1, "Dielectric constant measurement of solid materials using the HP 16451B dielectric test fixture," *HP literature number 5950-2390*, October 1989.
5. Application Note 369-7, "Measurement of capacitance characteristics of liquid crystal cells," *HP literature number 5950-2994*.
6. Product Note 8510-3, "Materials measurements - Measuring the dielectric constant of solids with the HP 8510 network analyzer," *HP literature number 5954-1535*, August 1985.
7. RF & Microwave Measurement Symposium and Exhibition Paper, "High frequency dielectric materials measurements," April 1991.
8. RF & Microwave Measurement Symposium and Exhibition Paper, "Measuring complex permittivity and permeability at RF and microwave frequencies," September 1989.
9. **HP 16451B Dielectric Test Fixture Data Sheet**, *HP Literature Number 5950-2368*, May 1989.
10. **HP 85070A Dielectric Probe Kit Data Sheet**, *HP Literature Number 5952-2381*, February 1991.
11. **HP 85071A Transmission Line Software Data Sheet**, *HP Literature Number 5952-2382*, February 1991.